

Sweet Girl Sweater

Crochet

©2013 France Nadeau



❁ Difficulty level : Low

❁ Size : 4 years-old

About the sweater

I have created this sweater to keep a lovely little girl warm. I chose a silky yarn in pink and beige. You can of course choose different colors. In this pattern, I included details perfect for a girl: a hardanger-embroidery-like effect and a contrasting scallop borders.

Planning

Back

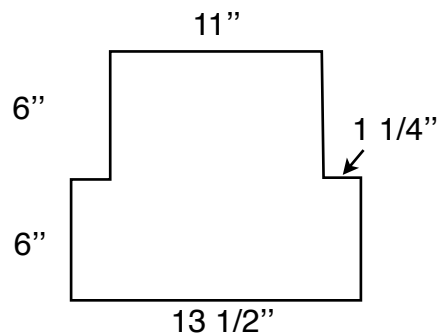

Right and left fronts

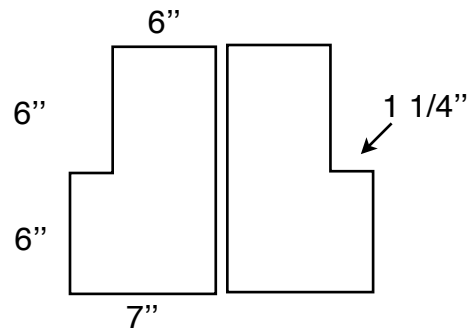

Three-quarter sleeves

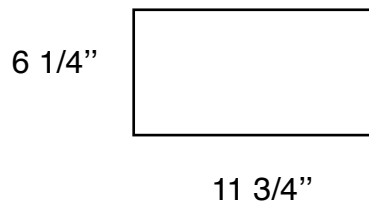

These are the measurements before assembling and before crocheting the borders.

Materials

- Medium-size yarn (I used Caron Simply Soft 100% acrylic)
 - I. Color #1 : 1 skein dark beige (bone) approximately 6oz/170g - 315yds/vgs/288m
 - II. Color #2 : 1 skein dark pink (plum wine) approximately 6oz/170g - 315yds/vgs/288m
- Crochet 4.5 mm (7 US)
- Yarn needle
- Four buttons

Back

Use color #1

- Chain 53.
- On the chain, crochet a row of double crochets every two chain stitches (you are working on the right side): *1 dc, 1 chs*. End with a double crochet.

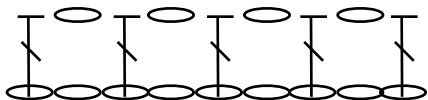

- Crochet a row of single crochets (wrong side).
- Crochet a second row of double crochets every two stitches (right side): *1 dc, 1 chs*. End with a double crochet.
- Crochet a second row of single crochets (wrong side).

Use color #2

- Crochet two rows of double crochets.

Use color #1

- 6 rows of double crochets.
- 1 row of double crochets; do not crochet 5 stitches on each side (1 1/4"):
 - at the beginning of the row: work your way to the sixth stitch with slip stitches;
 - at the end of the row: do not crochet the last 5 stitches (but crochet the sixth stitch before the last five stitches).
- 11 rows of double crochets.

Left front

Use color #1

- Chain 29.
- On the chain, crochet a row of double crochets every two chain stitches (you are working on the right side): *1 dc, 1 chs*. End with a double crochet.
- Crochet a row of single crochets (wrong side).
- Crochet a second row of double crochets every two stitches (right side): *1 dc, 1 chs*. End with a double crochet.
- Crochet a second row of single crochets (wrong side).

Use color #2

- Crochet two rows of double crochets.

Use color #1

- 6 rows of double crochets
- Do not crochet the 5 stitches on the right (facing you).
- 12 rows of double crochets.

Right front

Reverse.

Sleeves

Use color #1

- Chain 49.
- On the chain, crochet a row of double crochets every two chain stitches (you are working on the right side): *1 dc, 1 chs*. End with a double crochet.
- Crochet a row of single crochets (wrong side).
- Crochet a second row of double crochets every two stitches (right side): *1 dc, 1 chs*. End with a double crochet.
- Crochet a second row of single crochets (wrong side).

Use color #2

- Crochet two rows of double crochets.

Use color #1

- 8 rows of double crochets.

Assembling the shoulders

Stitch together both shoulders with color #1: 2" on each side of the neckline. 7" will be left in the center for the neck opening.

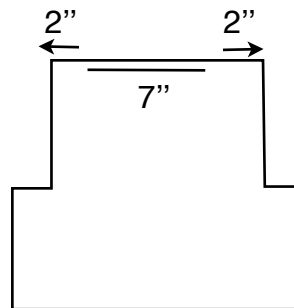

Assembling the sleeves

Stitch the sleeves with color #1. Open the garment, place it on a flat surface (wrong side up) and assemble the sleeves.

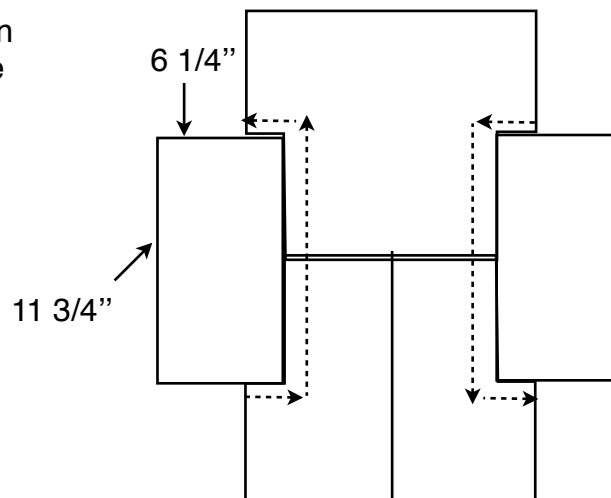

Assembling the sides and the underarms

Using color #1, stitch the sides and the underarms.

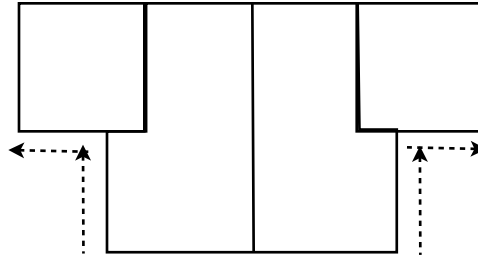

Borders on the sleeves

Using color #2, crochet a row of double crochets on the right side. Then, crochet a row of scallops made of 3 double crochets: 1 ss, *3 dc two stitches farther, 1 ss two stitches farther*. End with a slip stitch.

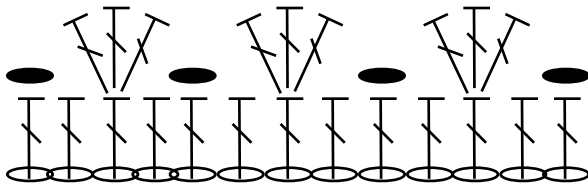

Borders on the front, the neckline and the bottom

Start with the bottom and continue (do not cut the yarn) with the right front, then the neckline, then the left front. Using color #2, crochet a row of double crochets on the right side. Then, crochet a row of scallops made of 3 double crochets: 1 ss, *3 dc two stitches farther, 1 ss two stitches farther*. End with a slip stitch.

Finishing

Sew a button at a distance of $2 \frac{3}{8}$ " from the bottom. Then sew 3 more buttons at a distance of 2" each from the last.